

Inquiry form

M2 styli



Styli straight

Quantity:

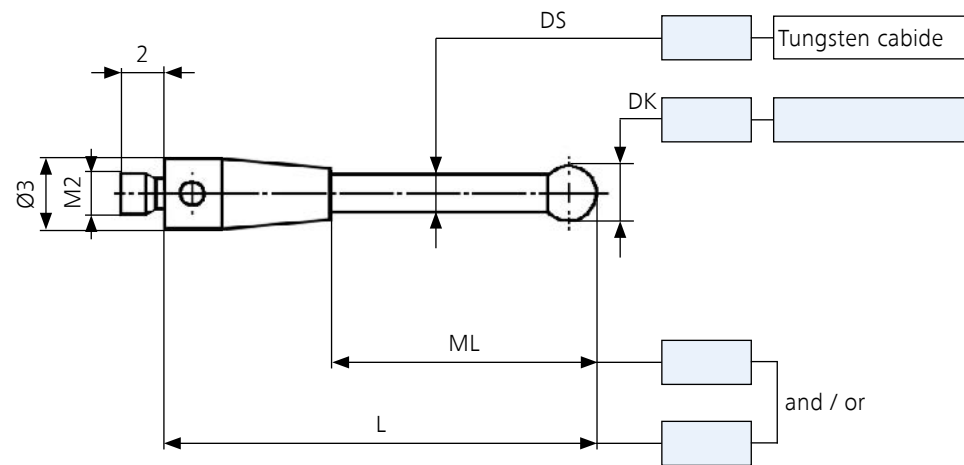

Styli stepped

Quantity:

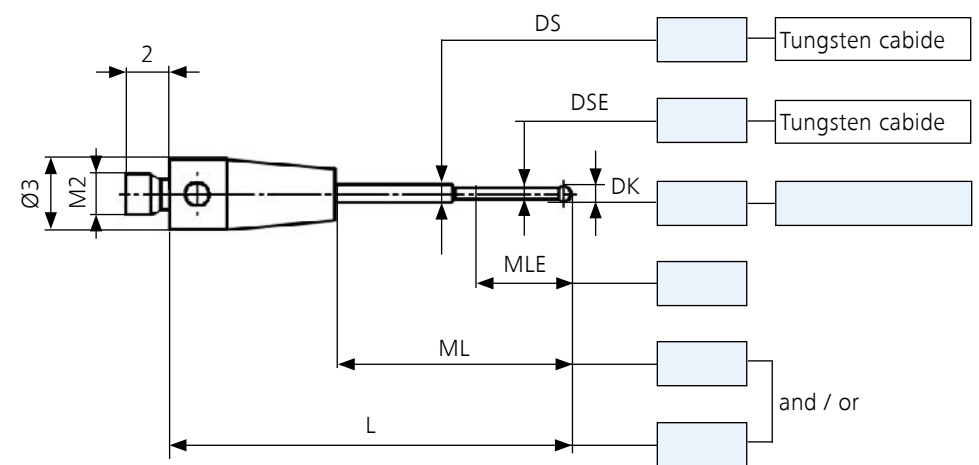

Contact details:

Customer no.:

Company:

Department:

Zip code:

Name:

Email:

Street, no.:

City :

First name:

Phone:

Please fill in all blue fields. Enter your desired dimensions in mm and the angles in degrees.

Send by e-mail to:

accessories.metrology.de@zeiss.com